

# ECMA

UNSERE STANDARDS

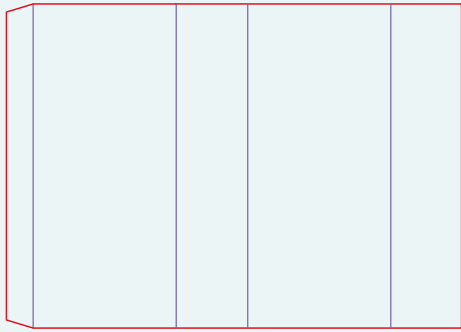

A 0101

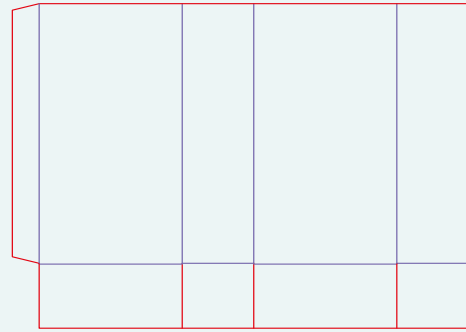

A 1001

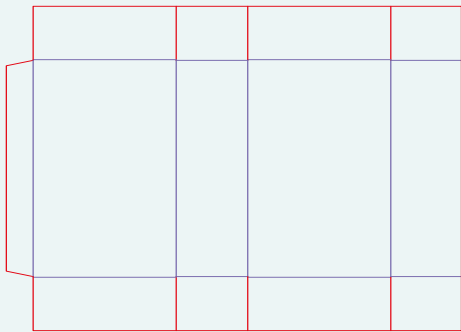

A 1010

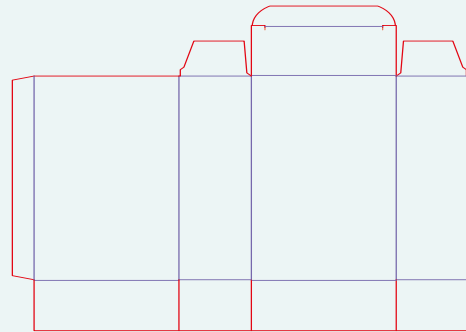

A 1020

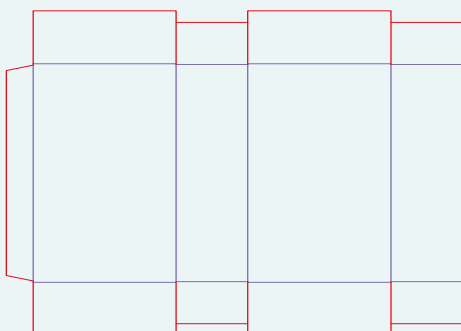

A 1111

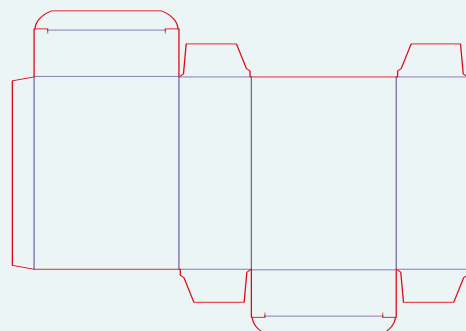

A 2120

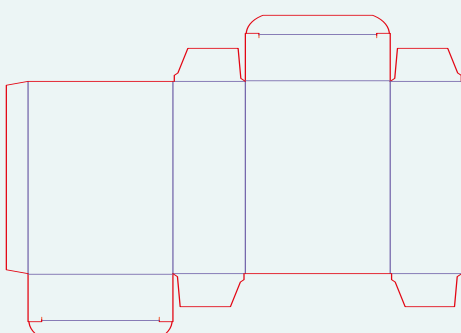

A 2220

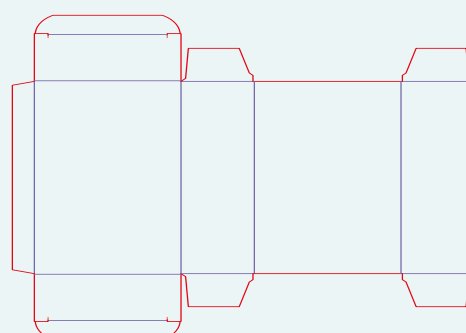

A 2320

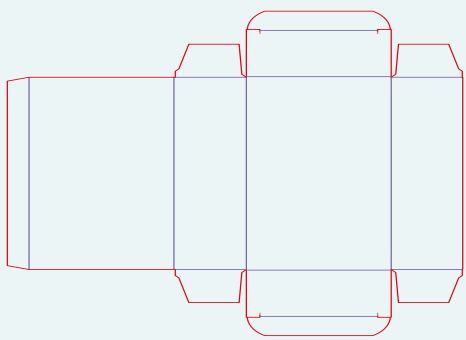

A 2420

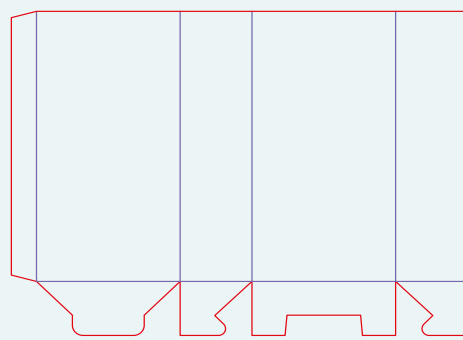

A 5501

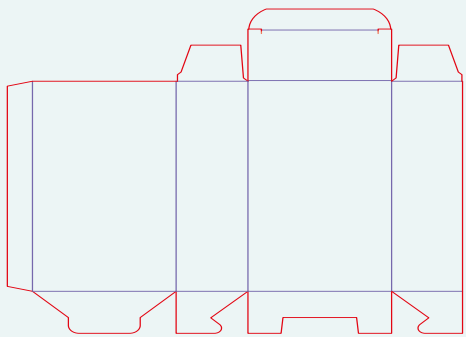

A 5520

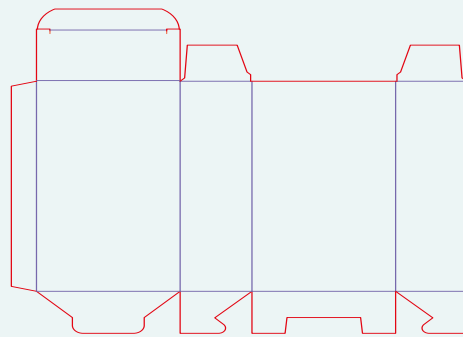

A 5520'

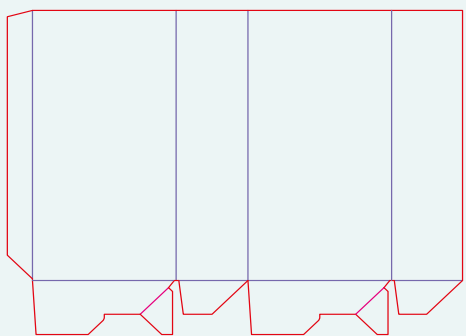

A 6001

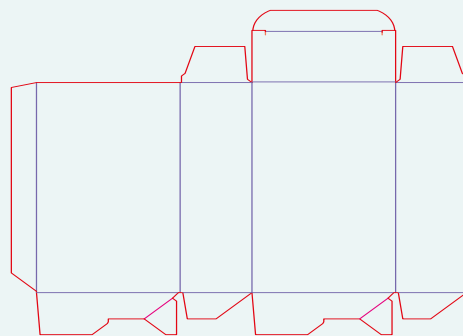

A 6020

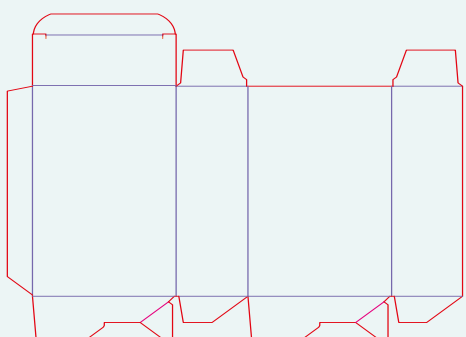

A 6020'

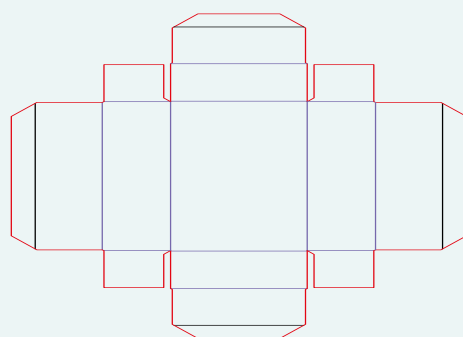

B 1010

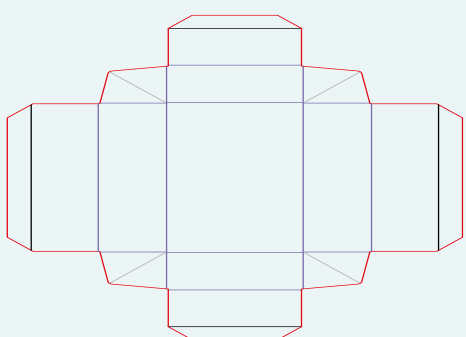

B 1011

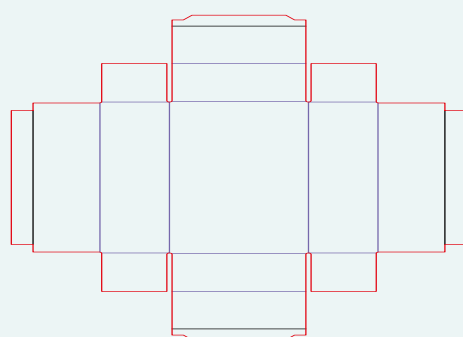

B 1020

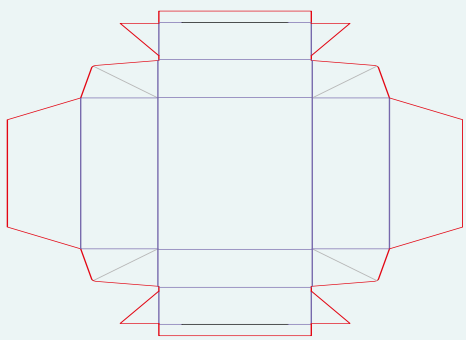

**B 1021**

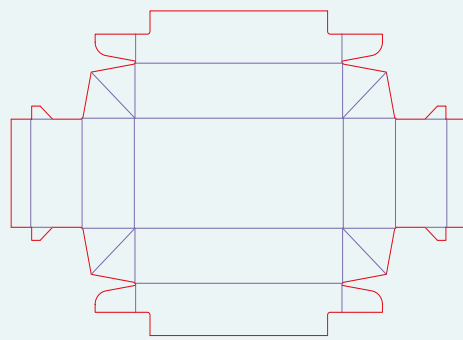

**B 1111**

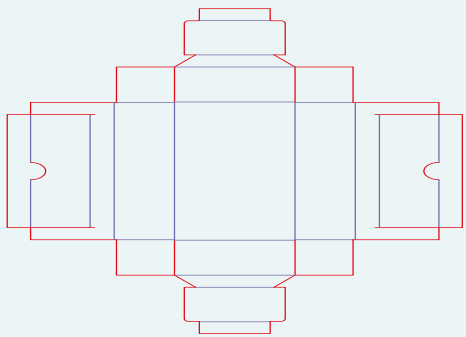

**B 1410**

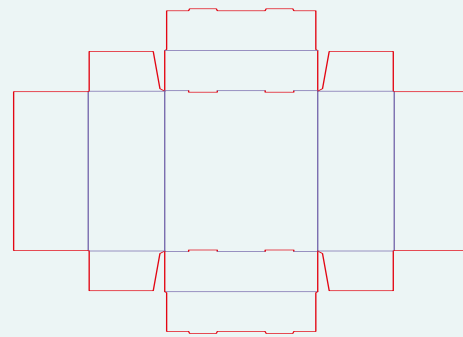

**B 2020**

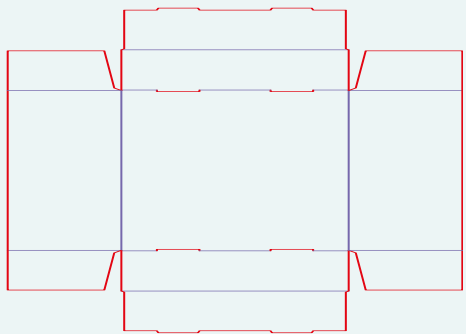

**B 2110**

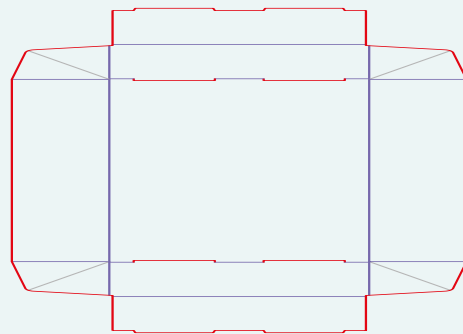

**B 2111**

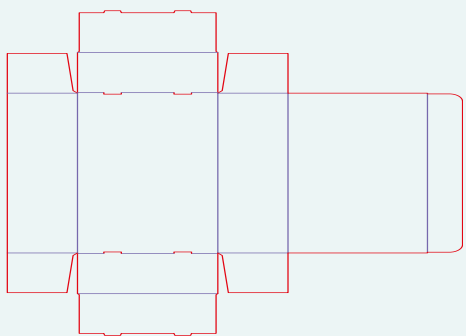

**B 2150**

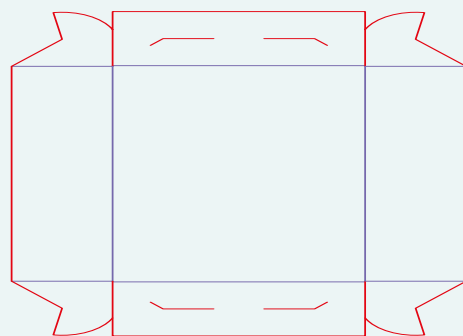

**B 3101**

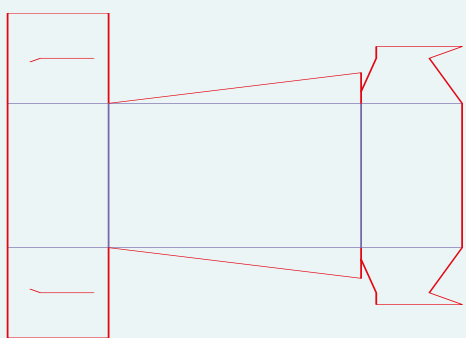

**B 3110**

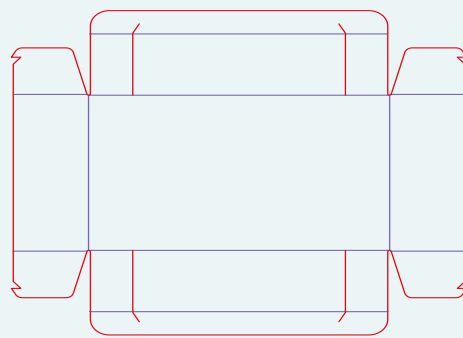

**B 3201**

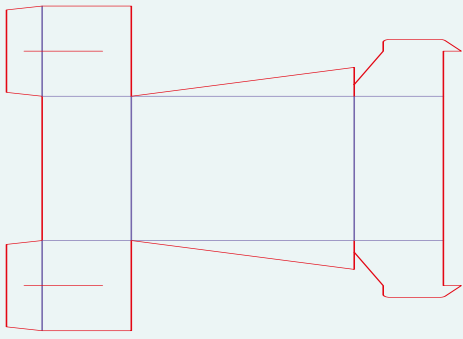

B 3210

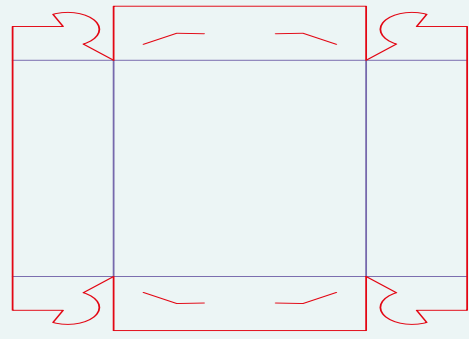

B 1310

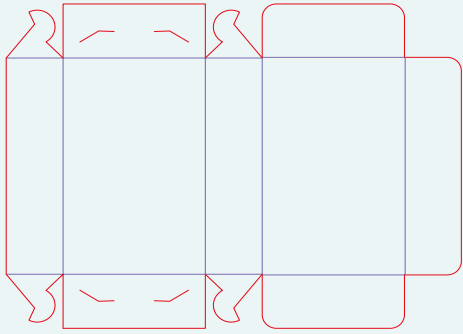

B 3353

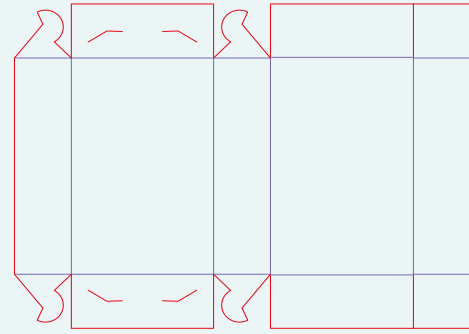

B 3360

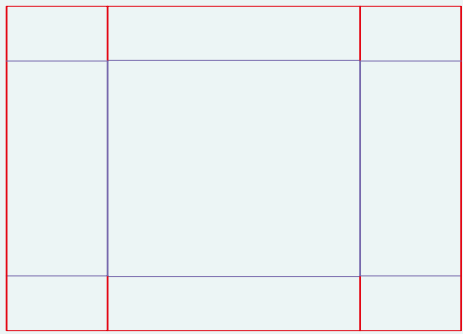

B 4010

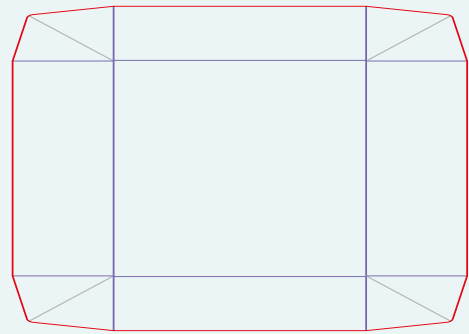

B 4011

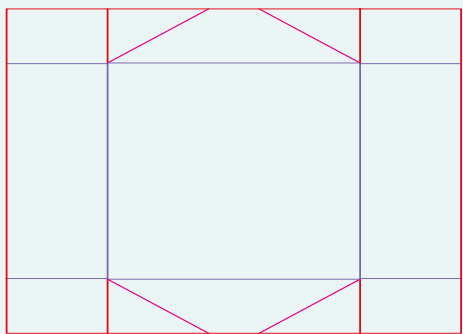

B 4020

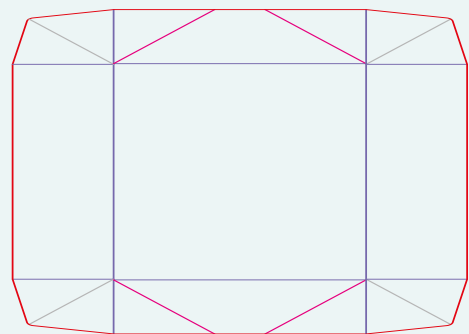

B 4021

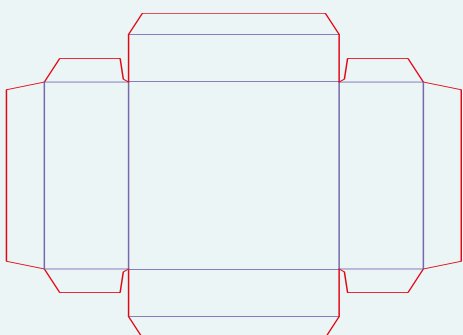

B 4110

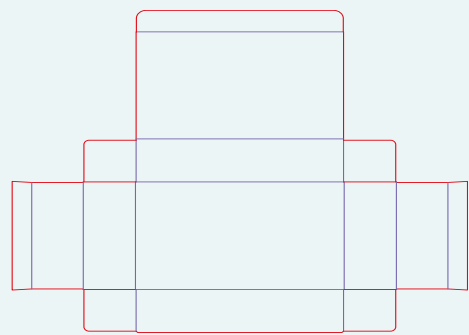

B 4150

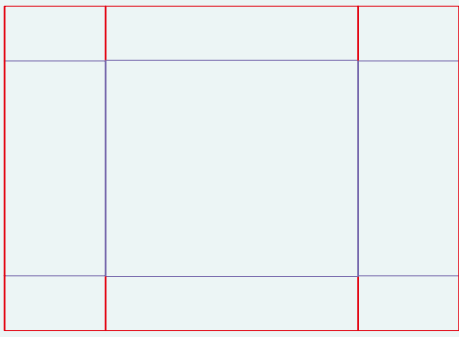

B 4410

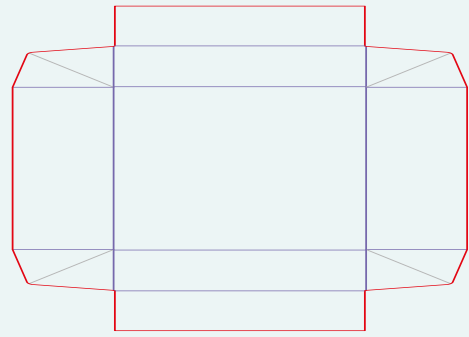

B 4411

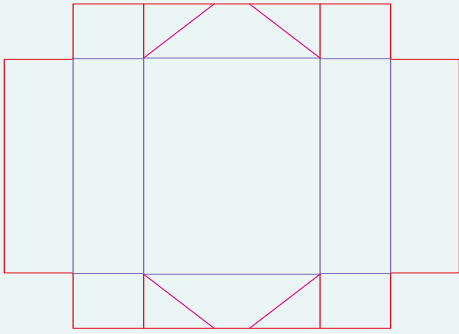

B 4420

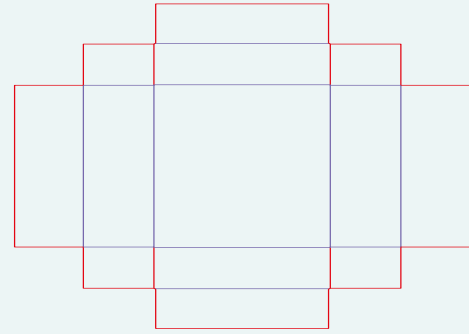

B 4810

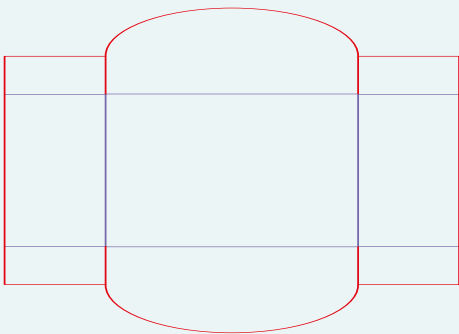

B 4910

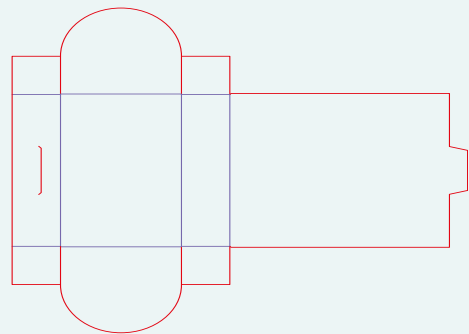

B 4950

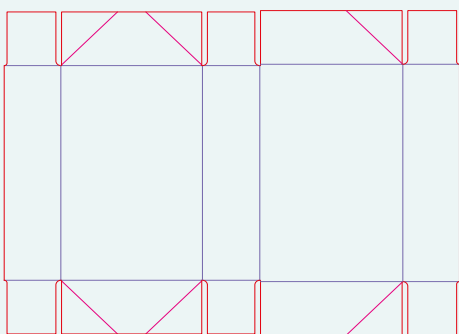

B 6020

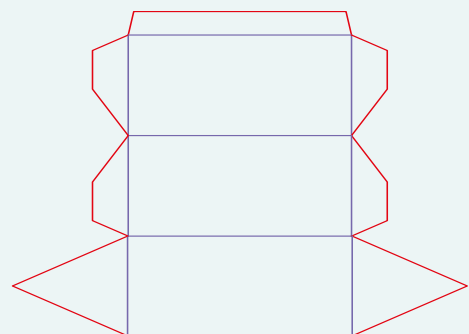

C 1011

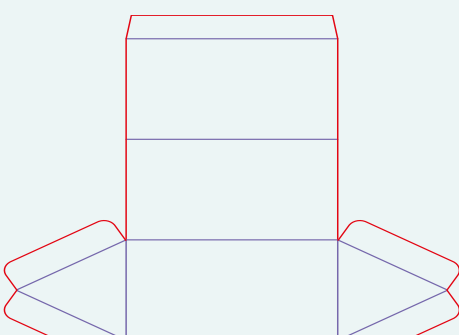

C 1020

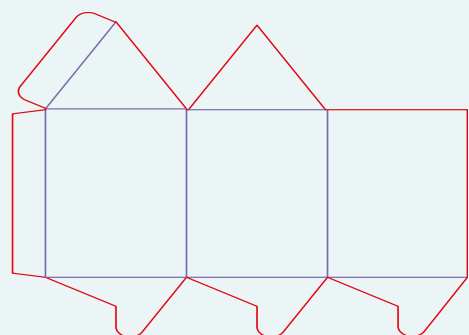

B 1055

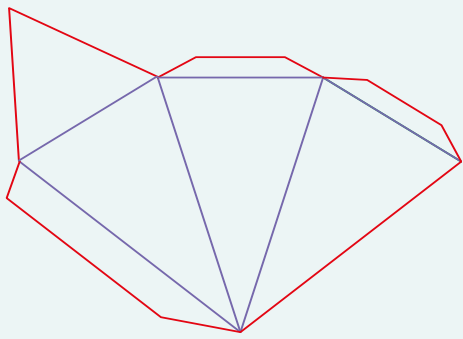

C 1211

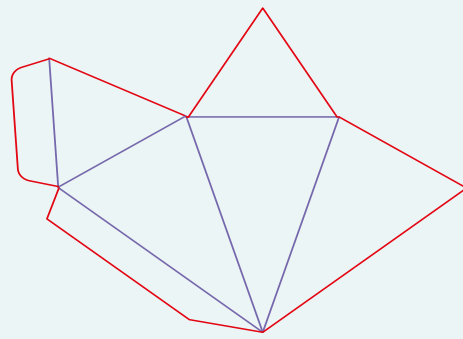

C 1220

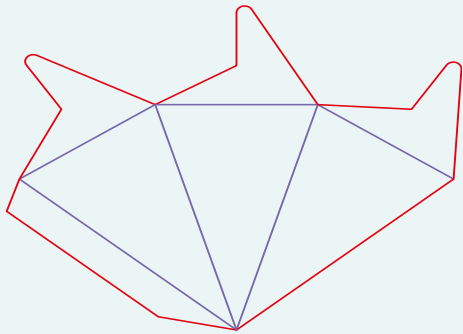

C 1255

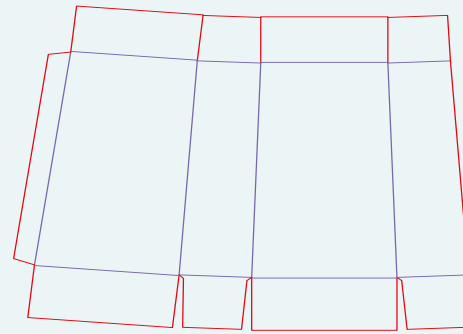

C 2110

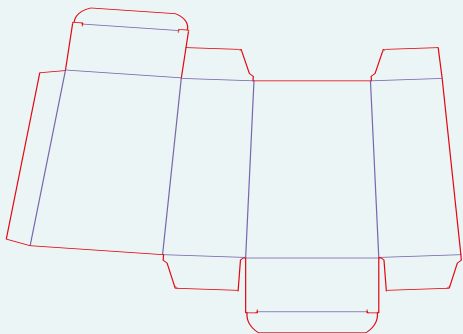

C 2120

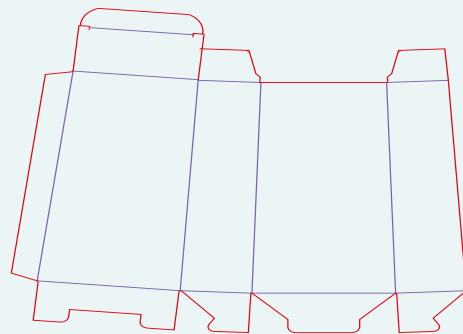

C 2155

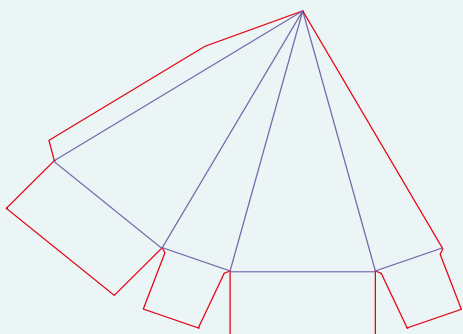

C 2210

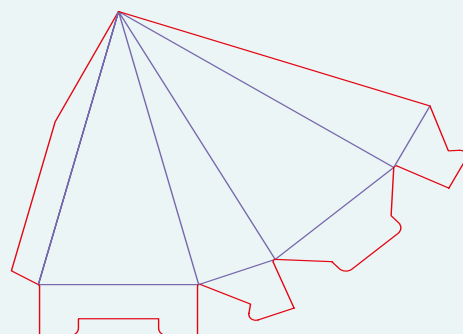

C 2255

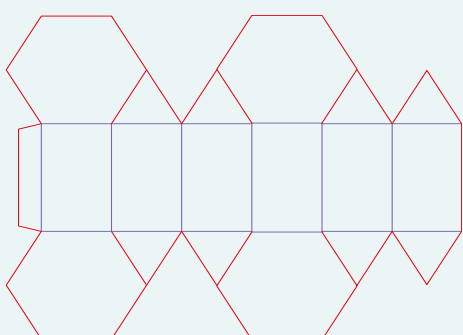

C 4010

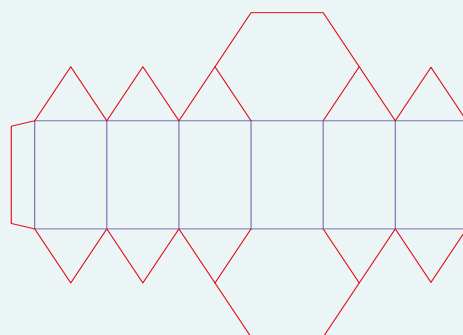

B 4011

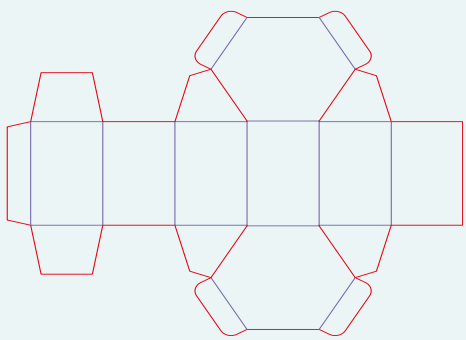

C 4020

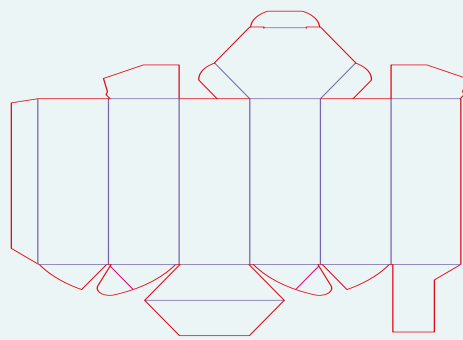

C 4060

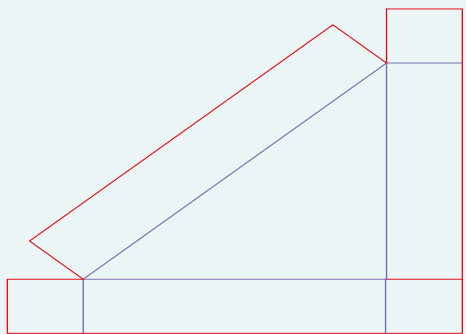

D 1010

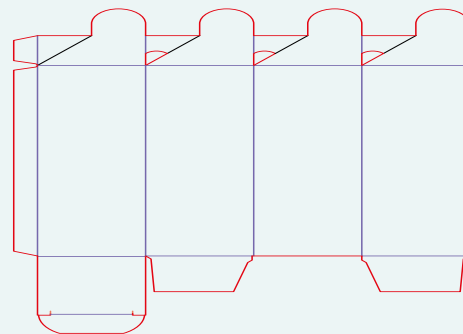

F 1021

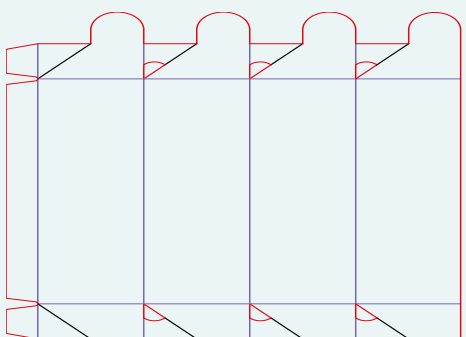

F 1022

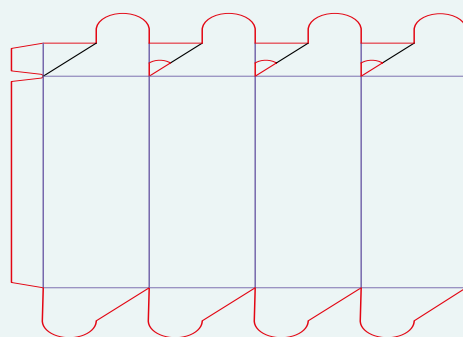

F 1023

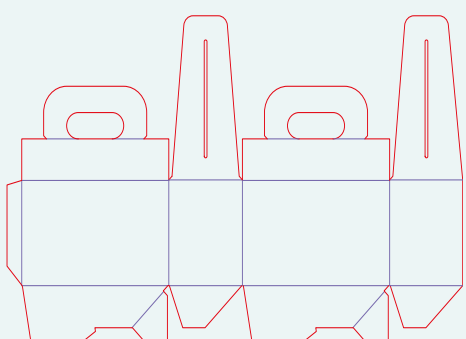

F 1034

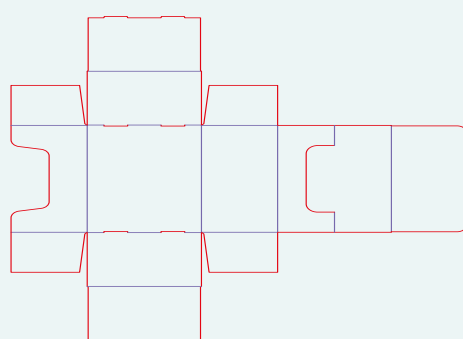

F 2011

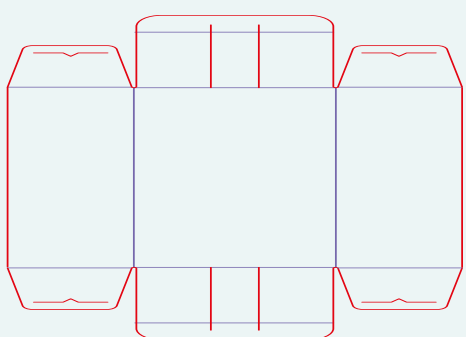

F 2021

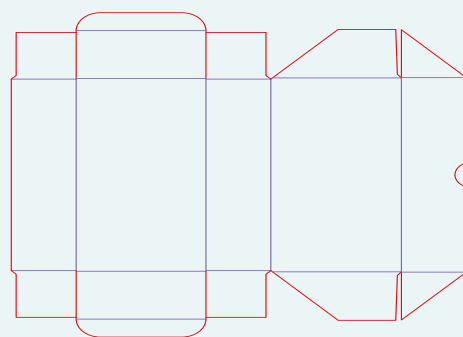

F 2032

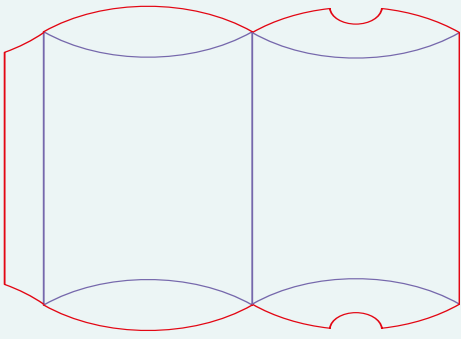

F 7001

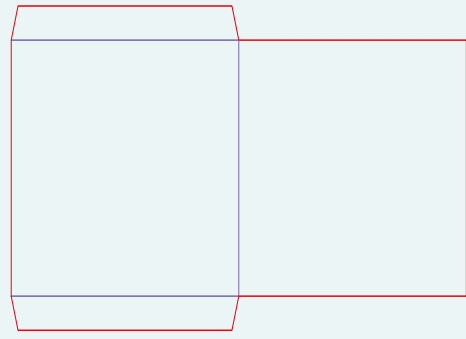

F 7011

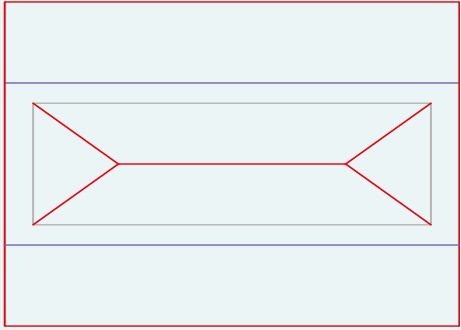

F 8002



# FEFCO

UNSERE STANDARDS

